

# DPM® LANDMARK STRUCTURES® BUILDING KIT



## KONRAD PAINT CO. #95200

**Konrad Paint Co. is a building kit designed from O scale Modular Building System™ parts.**

Read the General Modular Instructions and Konrad Paint Co. Modular Kit Instructions before beginning construction.

The General Instructions included with this kit provide preparation, assembly and construction information for all O scale Modular kits. The drawings on the Konrad Paint Co. Modular Kit Instructions specify parts placement and assembly information for constructing this kit. Use both sets of instructions during construction.

**NOTE:** Pay special attention to the steps in the Preassembly, Pilasters/Corner Pilasters and Wall Assembly sections in the General Instructions. These steps are necessary for proper assembly.

### VIEWS

In the Konrad Paint Co. Instructions, Views illustrate how individual parts are glued together to form flat wall assemblies. Compare Views with Drawing #1 and #2 for assembly information.

### DRAWINGS

To assemble Konrad Paint Co., refer to the Drawings for proper placement of flat wall assemblies. There are letters at the corners, and each letter listed is used twice (front view and reverse view). The letters illustrate where flat wall assemblies are joined to form a right angle.

### PILASTER ASSEMBLIES

Refer to the Pilasters/Corner Pilasters section in the General Instructions for information on Left and Right Corner Pilaster Assemblies. Corner Pilaster Assemblies space walls correctly and strengthen the corners. For larger wall assemblies, see the Miscellaneous note at the bottom of the General Instructions.

### ROOF

Refer to the Roof/Roof Supports section in the General Instructions for information on roof installation.

### FINISHING TOUCHES

Complete the painting and window installation of Konrad Paint Co. by following Painting and Install Windows sections in the General Instructions. Add lights to your buildings quickly and easily using the Woodland Scenics Just Plug® Lighting System. Visit woodlandscenics.com for more painting and weathering ideas.

**NOTE:** There is nothing sacred in Konrad Paint Co. Instructions. You can build it exactly as shown, or you can change the placement of walls to suit your needs. You can also add parts from other O scale Modular System kits to this kit and create a unique structure.

**Konrad Paint Co. ist ein Bausatz aus O-Maßstab Modular Building System Teilen.**

Lesen Sie die General Modular Anweisungen und Konrad Paint Co. Modular Kit Anweisungen bevor Sie mit dem Bau beginnen.

Die in diesem Kit enthaltenen allgemeinen Instruktionen enthalten Vorbereitungs-, Montage- und Konstruktionsinformationen für alle O-Skala-Modulsätze. Die Zeichnungen auf der Konrad Paint Co. Modular Kit Instruktionen spezifizieren Teile Platzierung und Montage Informationen für den Bau dieses Bausatzes. Verwenden Sie beide Sätze von Anweisungen während des Baus.

**HINWEIS:** Achten Sie besonders auf die Schritte der Vormontage, Pilaster / Ecke Pilaster und Wandmontage in der Allgemeinen Anweisungen. Diese Schritte sind für die ordnungsgemäße Montage erforderlich.

### ANSICHTEN

In den Konrad Paint Co. Anweisungen verdeutlichen die Ansichten, wie einzelne Teile zusammengeklebt werden, um flache Wandbaugruppen zu bilden. Vergleichen Sie die Ansichten mit den Zeichnungen # 1 und # 2 für spezifische Montageinformationen.

### ZEICHNUNGEN

Um Konrad Paint Co. zusammenzubauen, siehe die Zeichnungen für die richtige Platzierung von Flachwandmontagen. Es gibt Briefe an den Ecken, und jeder Buchstabe wird zweimal verwendet (Vorderansicht und Rückansicht). Die Buchstaben zeigen, wo flache Wandanordnungen zu einem rechten Winkel verbunden sind.

### PILASTER-MONTAGE

Weitere Informationen finden Sie im Abschnitt "Pilaster / Corner Pilaster" in der Allgemeinen Anweisungen zur Information über Links- und Rechtsecken-Pilaster-Baugruppen. Corner Pilaster versammelt Raumwände korrekt und stärkt die Ecken. Bei größeren Wandbaugruppen siehe die Bemerkung unten unten auf der allgemeinen Anweisungen.

### DACH

Weitere Informationen zur Dachinstallation finden Sie im Abschnitt Roof / Roof Supports in der Allgemeinen Anweisungen.

### FEINSCHLIFF

Füllen Sie die Malerei und Fenster Installation von Konrad Paint Co., indem Sie Malerei und Installieren Windows Abschnitt in der Allgemeinen Anweisungen. Fügen Sie Ihrem Gebäude schnell und einfach Licht mit dem Woodland Scenics Just Plug Lighting System hinzu. Besuchen Sie woodlandscenics.com für mehr Malerei und Verwitterung Ideen und erfahren Sie mehr über Just Plug.

**HINWEIS:** Es gibt nichts heilig in Konrad Paint Co. Anweisungen. Sie können es genau wie gezeigt zu bauen, oder Sie können die Platzierung von Wänden ändern, um Ihre Bedürfnisse anzupassen. Sie können auch Teile von anderen O-Skala-Modular-System-Kits zu diesem Kit hinzufügen und eine einzigartige Struktur erstellen.

**Drawing #1  
Zeichnung #1**

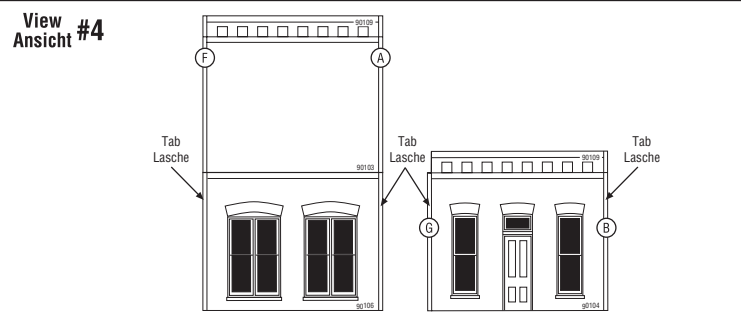
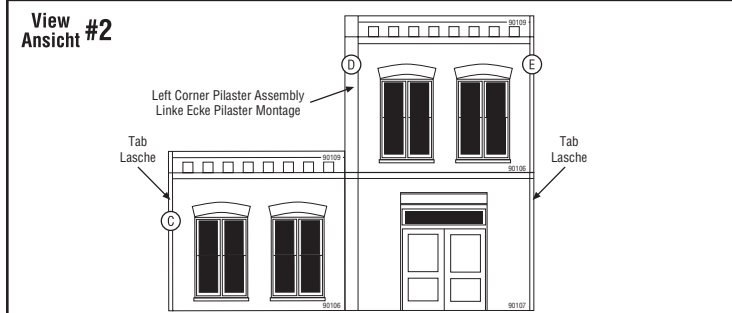
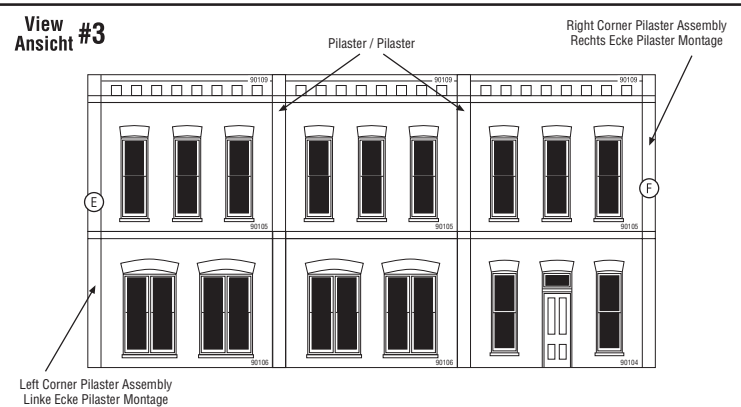
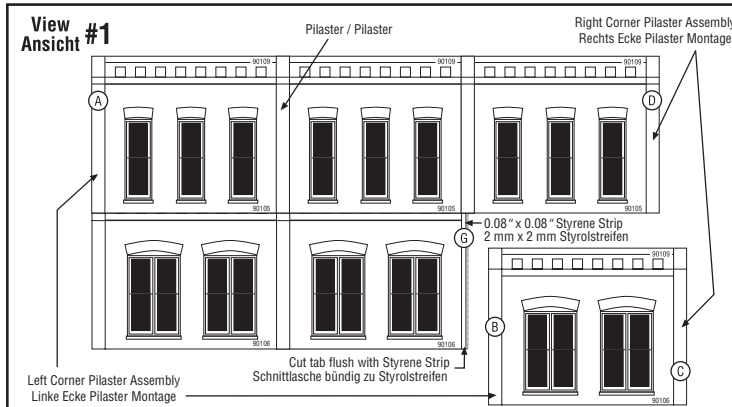
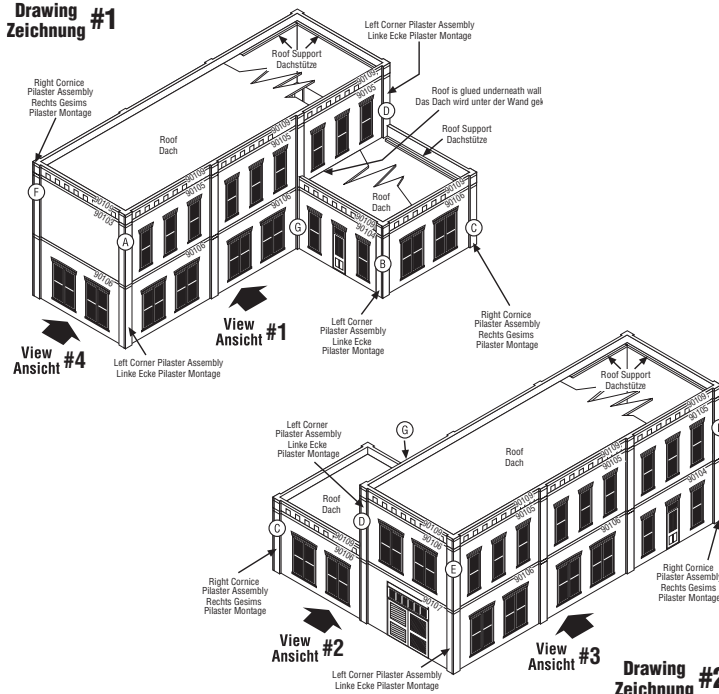

**CAUTION:** Cutting tools recommended. Use with care. / **ACHTUNG:** Schneidwerkzeuge empfohlen. Mit Vorsicht benutzen.

**MODELING AND CARE INFORMATION** This kit suggests the use of materials that may stain or cause damage. Take care to cover project area and clothing appropriately. Follow recommendations for use and cleanup.

**Model making product. Not a toy! Not suitable for children under 14 years! / Produit pour le modélisme. Pas un jouet! Pas adapté aux enfants de moins de 14 ans! / Producto para modelismo. No es un juguete! No adecuado para niños menores de 14 años! / Modellbauartikel. Kein Spielzeug! Nicht geeignet für Kinder unter 14!**



# O SCALE MODULAR WALL SYSTEM

Injection Molded Styrene

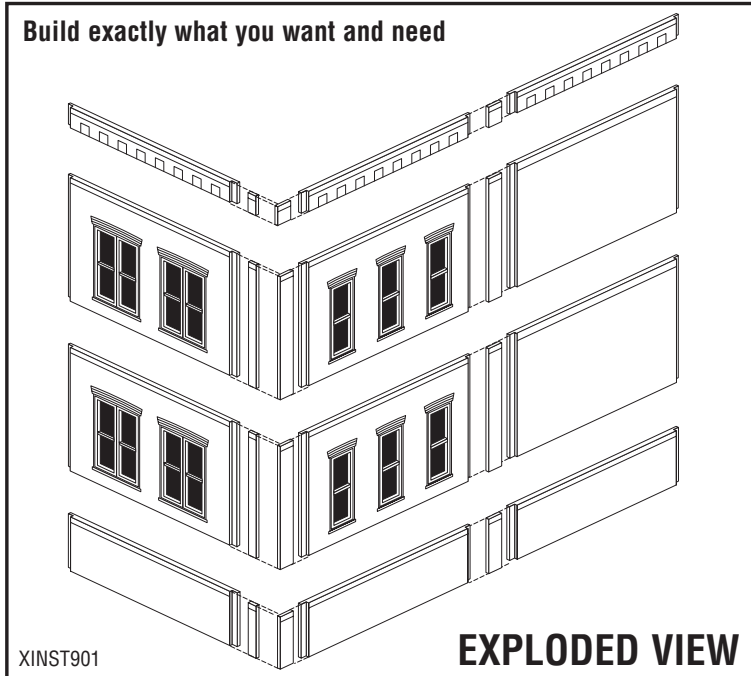

## 9 DIFFERENT WALL SECTIONS

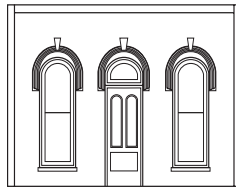

**Street/Dock Level  
Arched Entry**  
90101

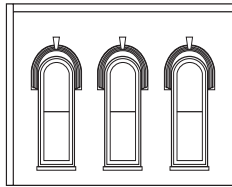

**Arched Window**  
90102



**Blank Wall**  
90103



**Street/Dock Level  
Rectangular Entry**  
90104

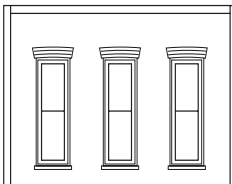

**Rectangular Window**  
90105

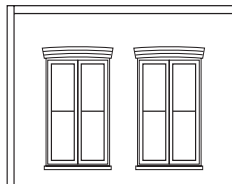

**Double Rectangular Window**  
90106

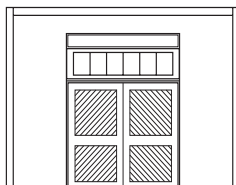

**Street/Dock Level  
Freight Door**  
90107



**Dock Riser Wall**  
90108



**Cornice**  
90109



**WOODLAND SCENICS®**  
Manufactured by **WOODLAND®**  
PO BOX 98, LINN CREEK, MO 65052 • woodlandscenics.com  
Made in USA • O11 ©2010 O CO

Distributed by Bachmann Europe, 13 Moat Way, Barwell, Leicestershire,  
LE9 8EY. ENGLAND. Am Umspannwerk 5, 90518 Altdorf b. Nürnberg. GERMANY.

Model making product. Not a toy! Not suitable for children under 14 years! / Produit pour le modélisme.  
Pas un jouet! Pas adapté aux enfants de moins de 14 ans! / Producto para modelismo. No es un juguete!  
No adecuado para niños menores de 14 años! / Modellbauartikel. Kein Spielzeug! Nicht geeignet für  
Kinder unter 14!

**CAUTION:** Cutting tools recommended. Use with care.

**MODELING AND CARE INFORMATION:** This kit suggests the use of materials that may stain or cause damage. Take care to cover project area and clothing appropriately. Follow recommendations for use and cleanup.

The **DPM 0 Scale Modular Building System™** provides unlimited options to plan and build structures suited to individual size and shape requirements. Build large or small buildings with two, three or more stories and with or without docks. When the desired height is achieved, finish the building with cornices.

The System includes seven different, interchangeable Wall Sections, a Dock Riser Wall Section and Cornice Section. All sections include Pilasters for joining two sections together and making corners. Parts are injection molded styrene. Use plastic model cement to adhere pieces together.

Figures 1 and 2 show a completed structure with views of the front and left side (**Fig. 1**) and the back and right side (**Fig. 2**). Item numbers are shown in the upper right corner of each individual Wall Section. A parts list for this building would consist of one package each of 90103, 90104, and 90107; two packages each of 90108 and 90109; and five packages of 90105.

There are unlimited building options with DPM Modular Building System. Substitute Rectangular Windows for Arched Windows, add a bay to the length, or add an additional story. Corner Pilaster Assemblies may be altered to make any angled corner desired or cut pieces on angles to make pitched roofs. The possibilities are endless.

**Additional materials needed but not included in Items 90101-90109:**

**To make Docks and Roofs:** 0.04" (1.01 mm) white styrene sheet

**To make Inside Corners and Roof Supports:** 0.08" (2.03 mm) square styrene strip

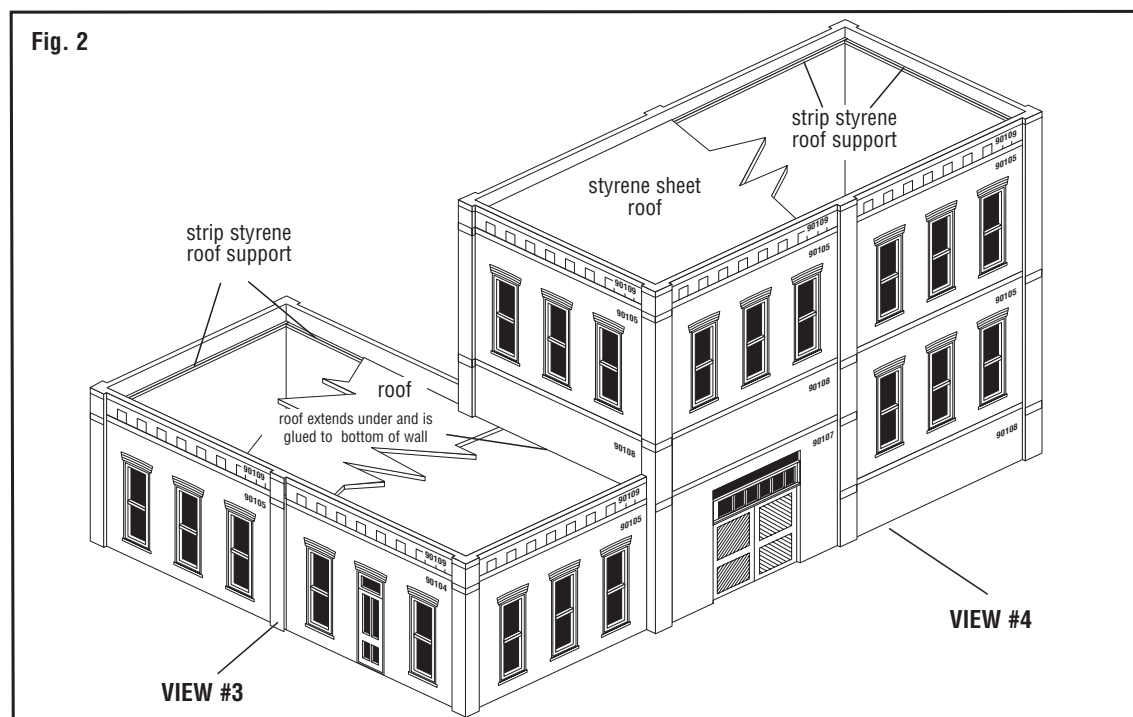
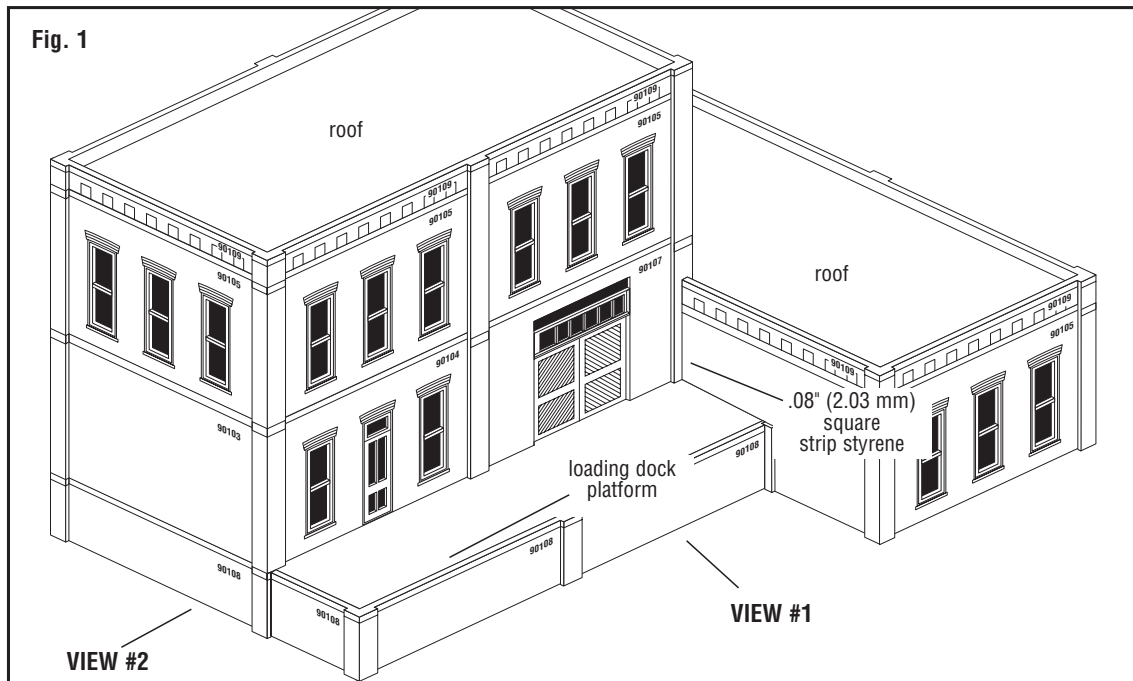

# GENERAL MODULAR INSTRUCTIONS

## READ THROUGH INSTRUCTIONS BEFORE BEGINNING.

### PLANNING

The O Scale Planning Packet (90191) includes full-sized wall section drawings. Photocopy the Planning Packet (full-sized, in multiples), glue to cardstock and cut out. Use cutouts to mock-up a full-sized building. Make buildings any height. Modify mock-up until satisfied with size and design. Use mock-up as a reference while constructing your building.

One-story buildings consist of Wall Sections glued together to create Single-Story Wall Panels topped with Cornice Sections.

Two-story buildings consist of Single-Story Wall Panels glued on top of one another and finished with Cornice Sections.

Add half stories using Dock Riser Wall Sections (90108) placed equally with Wall Sections to bring the floor even with the loading dock height (**Fig. 1 and 2**).

### PREASSEMBLY (Fig. 3)

Wash parts in warm, soapy water using a mild detergent. Rinse and let dry.

Use a hobby knife and sandpaper to remove excess plastic (flash) that occurred during the molding process.

**Flash:** Lightly scrape along edges to remove debris and sand smooth. Face the cutting edge of the blade

opposite the direction you scrape as to not cut into the part. **Sprue:** Remove parts by scoring with a hobby knife (flush with part) and snapping off. Sand any parting lines and mold flash. Keep parts on sprue until ready to use. **Tabs:** Sand smooth.

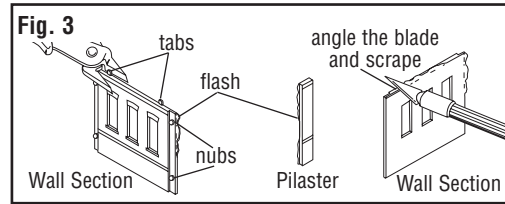

## GENERAL ASSEMBLY

Use solvent-based plastic cement to glue parts. Plastic cement works by dissolving the surface of plastic and welding parts together. Be careful to avoid contact with building details and visible areas on Clear Window Material. Allow glue to set between construction steps. Contact your local hobby shop for recommendations.

### PILASTERS

Each Pilaster sprue holds five pieces - three Wide Pilasters with brick detail on both edges and two Narrow Pilasters with detail on the left or right edge only.

Pilasters have beveled edges as a result of the molding process. When making an Outer Corner, the beveled edge from the non-detailed edge of the Narrow Pilaster will need to be sanded level.

To sand off the beveled edge, thumbtack a piece of 100-grit sandpaper to a flat surface and rub the non-detailed edge of the Narrow Pilaster back and forth, while holding it vertical to the sandpaper. A squaring block is useful (**Fig. 11**).

### WALL ASSEMBLY

Wall Sections are glued together horizontally with Pilasters to form Single-Story Wall Panels. Single-Story Wall Panels are glued on top of each other to create Multiple-Story Wall Panels. Finally, Multiple-Story Wall Panels are joined at the corners to make entire buildings (**Fig. 1 and 2**).

Following your pre-planned building design, place Wall Sections side-by-side (face up) horizontally. Keep glue off brick detail on Wall Sections and Pilaster by applying glue along outer edge of flanges. To help keep Wall Sections level, place a 1/8" (3.17 mm) thick straightedge along top edge of Wall Sections. (**Fig. 4**)

Fit Pilasters snugly into recessed area between Wall Sections (**Fig. 5**). Do not attach Pilasters to outer edges of Wall Panels at this time. Allow glue to set before moving on to the next construction step. While gluing horizontal Wall Panels, check each story against another to be sure Pilasters line up vertically.

Cornices (90109) are trim sections that set along the top of buildings. Assemble these in the same manner as Wall Panels. Check alignment of Cornice Pilasters with the Pilasters of the Wall Panels that set below.

For Outer Corners, attach Wide Pilasters to edges of Wall Panels that will be front and back of building. Attach Narrow Pilasters to edges of Wall Panels that will

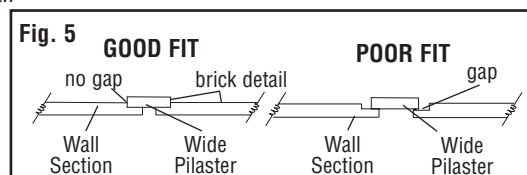
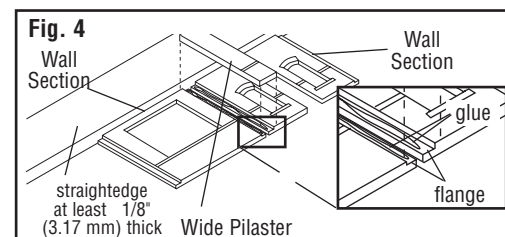

be sides of building (Fig. 6). Narrow Pilasters have brick detail on one edge and are smooth on the other (Fig 7). Smooth texture should face away from Wall Section. Wide and Narrow Pilasters will meet at outer corners and appear to be equal width on both sides (Fig. 8).

For Inside Corners, Pilasters are NOT used (Fig. 9). We suggest using 0.08" (2.03 mm) square styrene (purchased separately). Cut a portion of glue flange from one edge of a Wall Section that will make up an inside corner (Fig. 10 - Exploded View). The glue flange must be cut flush with square styrene (or short of it) so the adjacent glue flange will clear. Cut a piece of square styrene so it is flush with top and bottom of Wall and glue in place. (Fig. 10)

Allow glue on Single-Story Wall Panels to set overnight. To speed set-up time, turn Assembly over and use gap-filling CA glue at the joints. Wipe off excess glue, flip back over and lie flat to dry.

Level top and bottom of Wall edges on Single-Story Wall Panels. Using a squaring block, sand Walls level (Fig. 11). Repeat process on Cornice Assemblies and Dock Riser Wall Assemblies.

When sanding is complete, glue Single-Story Wall Panels on top of each other to complete Multi-Story Wall Panels (Fig. 12).

Use a squaring block and sandpaper to sand Wall Assembly edges and make sure corners will be square (Fig. 13).

Glue Multi-Story Wall Panels at their corners to create building (Fig. 14).

### PRIME AND PAINT

Paint building after Wall Assembly is complete. Roofs, decks for loading docks and window material should not be installed until after painting is complete. Apply a thin coat of primer before painting.

Colors are your choice. We recommend natural brick colors such as rust, tan or other earth tones. Paint door and window trim the same color as the brick or a contrasting color.

**Airbrush or Hand-brush:** Use flat finish, acrylic or enamel paint.

**Aerosol:** Use flat finish spray paint.

### Painting Tips and Techniques

**Interior Lighting:** If lighting building, reduce interior glare by painting interior walls and underside of roof flat black.

### Weathering Techniques

**Weather Walls or Add a Mortar-look:** Using a paintbrush, dab on small amounts of wash (formula follows) until desired look is achieved. Sponge off excess.

**Formula:** Mix 1-part acrylic paint (color suggestion: complimentary earth-tone shade), 12-parts rubbing alcohol, 8-parts water and 1 drop liquid dish soap.

**Airbrush:** Lightly spray thinned flat black paint (color suggestion: grimy black) to areas where natural discoloration can occur (near windows, chimneys, etc.).

**Chalk:** Rub a dark color of pastel chalk (color suggestion: gray, black, brown, etc.) on sandpaper to create a chalk dust. Using a paintbrush, dab chalk dust where discoloration can occur.

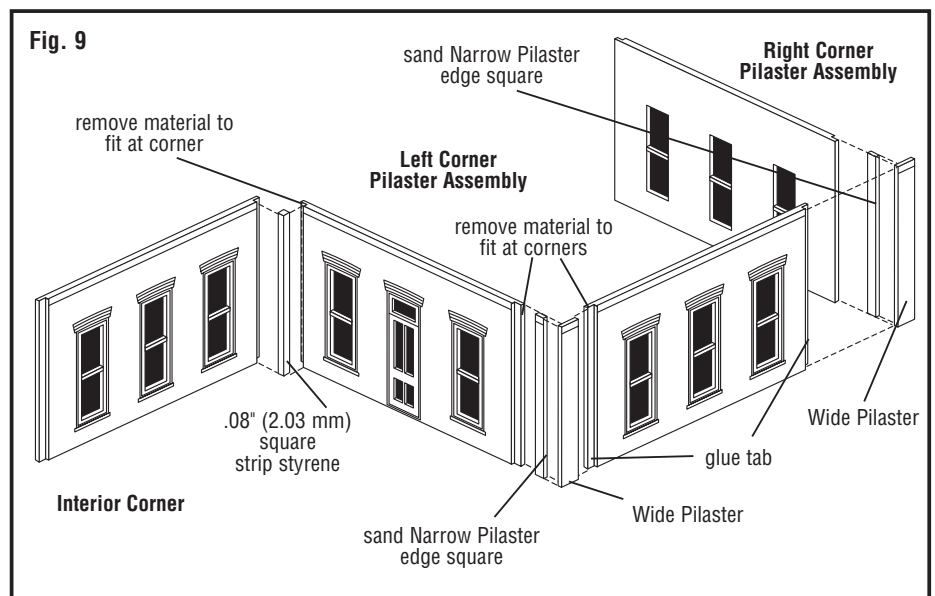
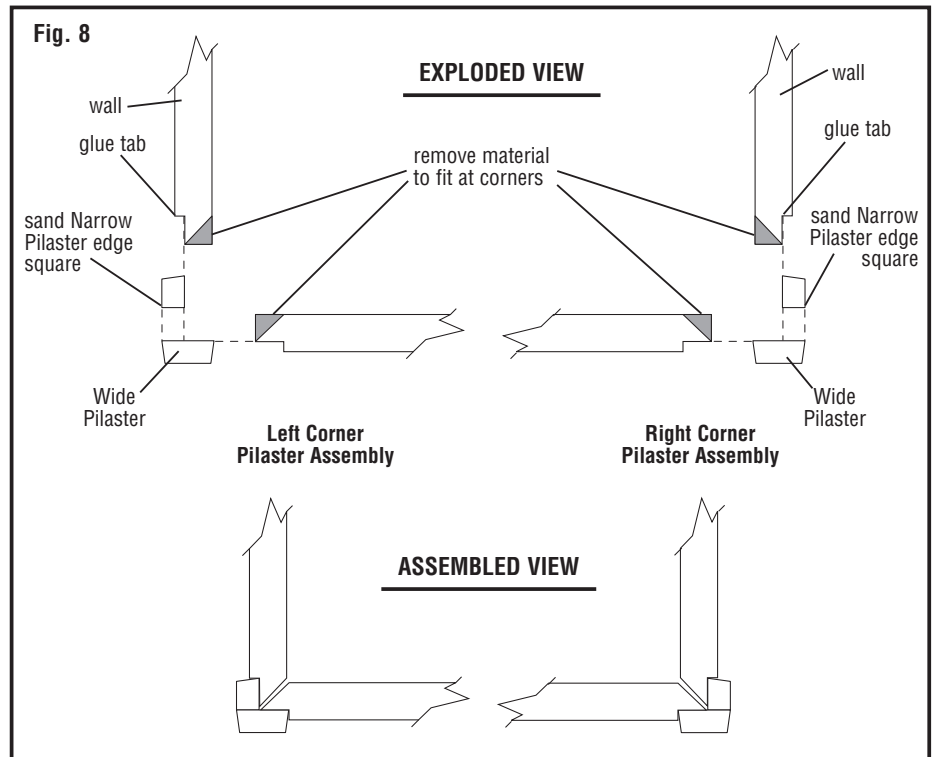
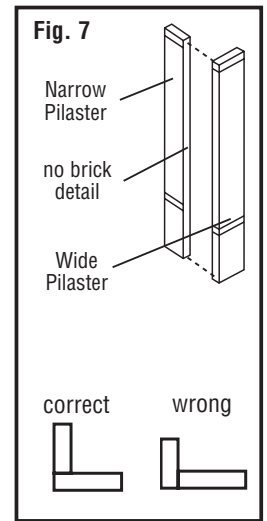
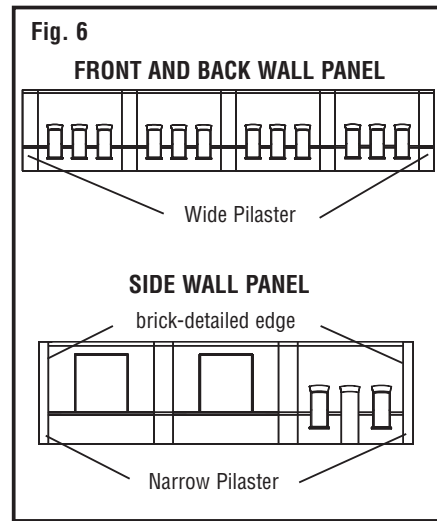

## ROOF AND ROOF SUPPORTS

Not included with individual Items 90101-90109. We suggest using 0.04" (1.01 mm) styrene sheet for Roof and 0.08" (2.03mm) square styrene strips for Roof Supports. Color suggestion: flat black.

Measure the inside dimension of roof opening(s). Transfer measurements to a piece of cardstock, cardboard, etc., cut out and test fit on building. Make adjustments as needed. Once you have achieved a good fit, transfer dimensions to Roof Material. Cut out using a hobby knife and ruler. Test fit and make any adjustments.

In cases where the roof over the first floor meets a second-story Wall, the roof should extend underneath the second-story Wall and is glued to the bottom (Fig. 2).

Glue Roof Supports to backside of Walls, approximately 1/16" (1.58 mm) under the connection point between the Cornice and the top of the Wall (Fig. 2).

## LOADING DOCKS

We suggest using 0.04" (1.01 mm) styrene sheet for the Dock Floor. Color suggestion: flat earth-tone and weathered with black. Not included.

Dock Riser Walls (90108) can be cut to size for desired width (Fig. 15).

Glue 0.08" (2.03 mm) square styrene strips (similar to roof supports) to the back side of Dock Riser Walls, approximately 1/16" (1.58 mm) below the top of the Wall. Make adjustments for thickness of dock material.

Measure and cut out dock floor. It should extend under the adjacent wall and the dock supports. Be sure to cut notches to clear Pilasters (Fig. 1 and 16). The dock platform should be flush with the top of the loading dock walls.

## INSTALL WINDOWS

Cut Clear Window Material to fit over windows on inside of building. Window installation is easier when material is installed over sections of windows at one time.

Place building on its front face, center window material over window(s) and carefully dab a small amount of glue around edges of window material. Do not let glue get on visible area of window material. Repeat for each set of window openings.

## MISCELLANEOUS

Exceptionally large wall panels and sections with no supporting wall below may require interior bracing.

Fig. 10

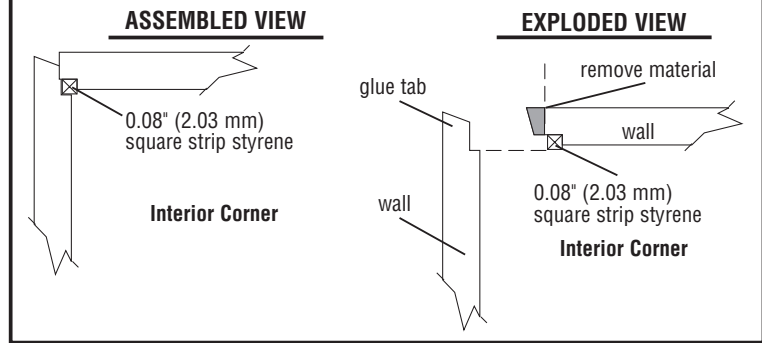

Fig. 11

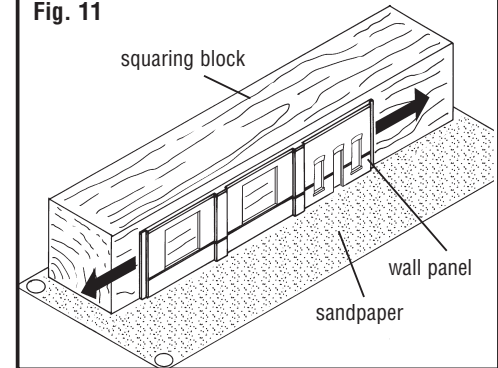

Fig. 12

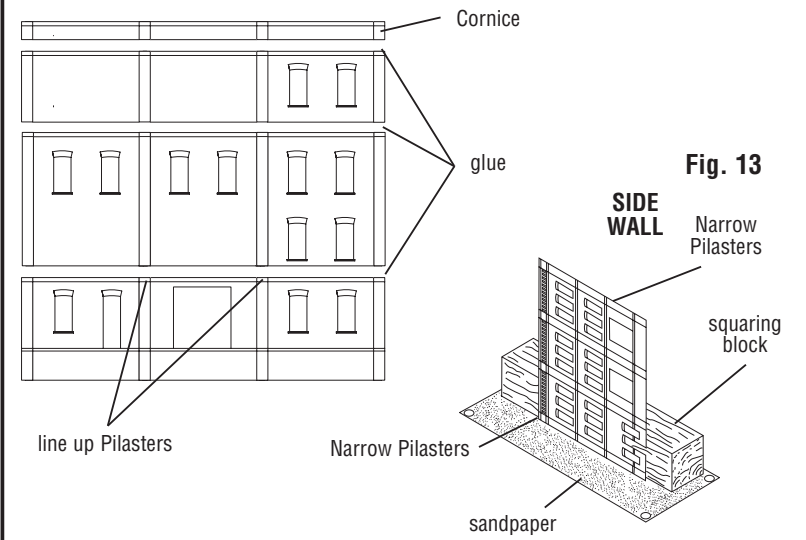

Fig. 15

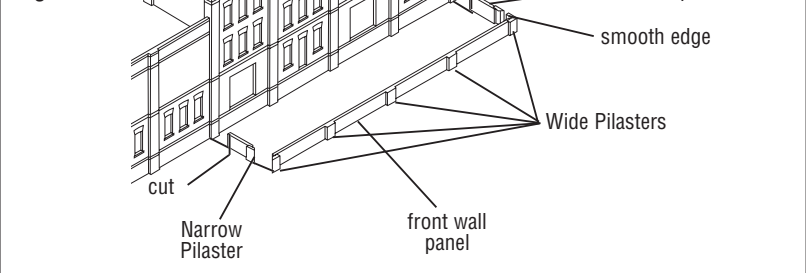

Fig. 16

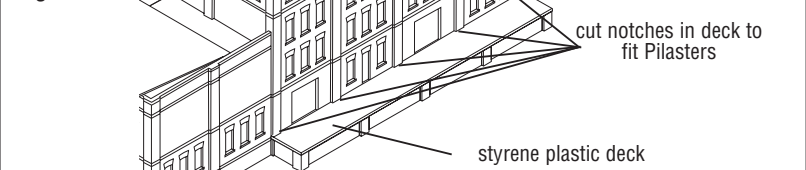
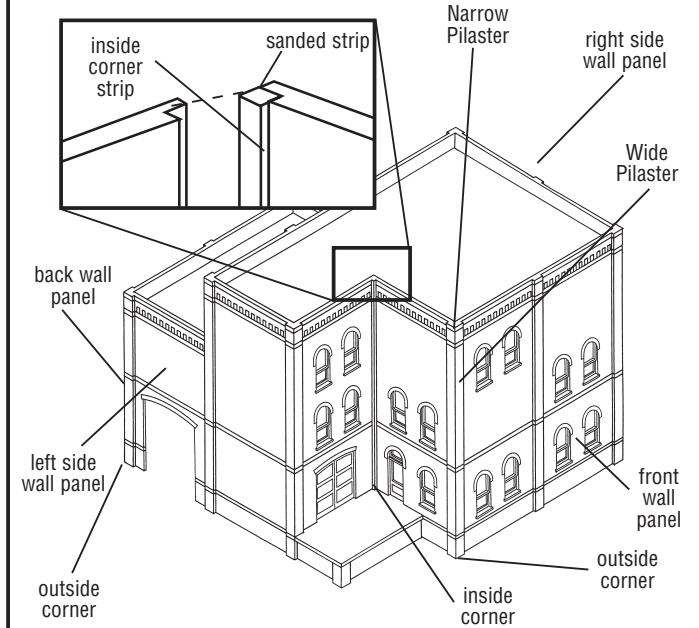

Fig. 14



# DPM® LANDMARK STRUCTURES® O SCALE MODULAR WALL SYSTEM

## PLANNING PACKET 90191



Refer to enclosed General Modular Instructions sheet to familiarize yourself with the Modular Wall System. All 9 Modular Wall Sections are reproduced full size on both sides of this Planning Sheet. Make multiple copies of the Planning Sheet. Cut out the Wall Sections and glue them onto cardstock. Note that each wall piece has Pilasters and a Cornice (90109) already in place on each Wall Section to reduce cutting and pasting. (Cornices and Pilasters do not come attached to the walls. Pilasters are included in each Wall Sections package. Cornices are available for purchase separately.) Use the Pilaster and Cornice as glue tabs between Wall Sections. Glue Pilasters over each other to make a single pilaster between walls. Use the Cornice as a glue tab when joining stories. An entire structure can be built in this manner - you will know in advance exactly how it will look on your layout and which parts you will need to purchase. Building/Wall Sections Copyright ©1992 by Design Preservation Models.

